

WELLINGTON

High back sofa for extra support and comfort

bellus®

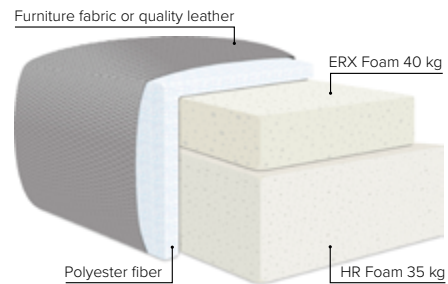
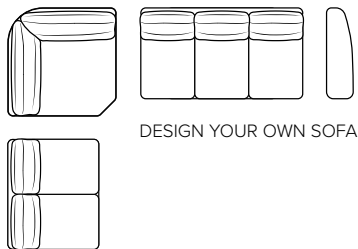

COMBINATIONS

Choose from available sofa models

MODULES

Design your own sofa

bellus®

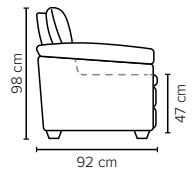
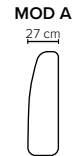
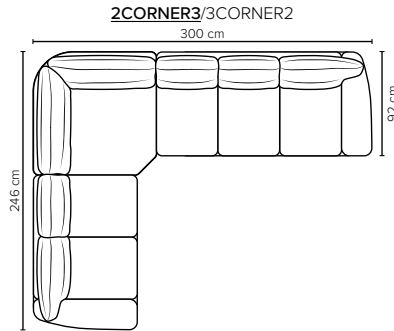
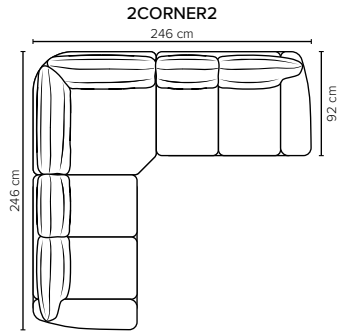
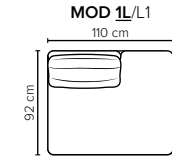
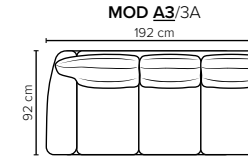
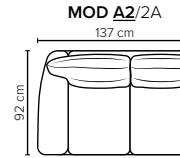
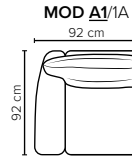
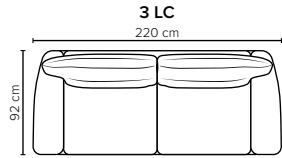
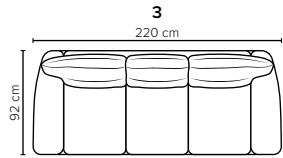
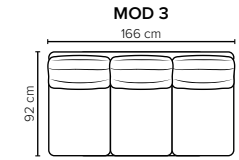
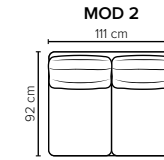
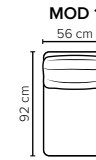
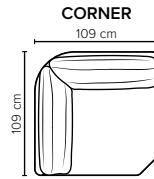
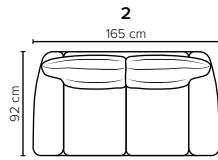
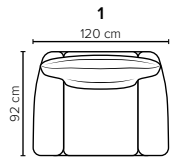

- SEAT:** HR foam 35kg + ERX foam 40kg covered with 200g fiber
- BACK:** Siliconized polyester fiber
Fixed seat cushions and fixed back cushions
- ARMREST:** Siliconized polyester fiber

- DECO PILLOWS:** Not included in this sofa model
Additional pillows can be ordered separately
- FRAME:** Plywood + wood
No-Sag springs
- LEG OPTIONS:** Standard: Leg 34 (wooden, h: 6 cm)

All measurements are approximate. Sofa height measured with leg 34. Please visit www.bellus.com for the latest product versions.



Leg 34